

HIP10N65T-SA

650V N-Channel Trench Field Stop IGBT

Features

- Very Low $V_{CE(sat)}$
- Extremely low switching loss
- Excellent stability and uniformity
- Soft Fast Reverse Recovery Diode
- Short Circuit Withstand Time 5.0 μs
- Maximum Junction temperature, $T_{J(max)}=175^{\circ}C$

Application

- Uninterruptible Power Supplies (UPS)
- Solar / Welding converters
- Motor drivers
- High frequency Converters

Key Parameters

Parameter	Value	Unit
V_{CES}	650	V
I_C	10	A
$V_{CE(sat)}$	1.38	V
E_{tot}	0.204	mJ

Package & Internal Circuit

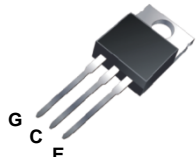
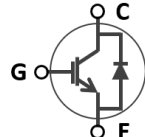
TO-220	SYMBOL
	

Absolute Maximum Ratings $T_C=25^{\circ}C$ unless otherwise specified

Symbol	Parameter	Value	Unit
V_{CES}	Collector-Emitter Voltage	650	V
V_{GE}	Gate-Emitter Voltage	± 20	V
I_C	Collector Current (@ $T_C = 25^{\circ}C$) (@ $T_C = 100^{\circ}C$)	20	A
		10	A
I_{CM}	Pulsed Collector Current (Note. 1)	40	A
I_F	Diode Continuous Forward Current (@ $T_C = 100^{\circ}C$)	10	A
I_{FM}	Diode Maximum Forward Current	40	A
P_D	Power Dissipation (@ $T_C = 25^{\circ}C$) (@ $T_C = 100^{\circ}C$)	81	W
		40	W
T_J	Maximum Operating Junction Temperature	175	$^{\circ}C$
T_{STG}	Storage Temperature Range	-55 to +175	$^{\circ}C$

Thermal Resistance Characteristics

Symbol	Parameter	Value	Unit
$R_{\theta JC}$	IGBT Thermal Resistance, Junction-to-Case, Max.	1.84	$^{\circ}C/W$
$R_{\theta JC}$	Diode Thermal Resistance, Junction-to-Case, Max.	2.4	$^{\circ}C/W$
$R_{\theta JA}$	Thermal Resistance, Junction-to-Ambient, Max.	40	$^{\circ}C/W$

Notes : 1. Repetitive Rating, Pulse width limited by maximum junction temperature

Electrical Characteristics $T_J=25^\circ\text{C}$ unless otherwise specified

Symbol	Parameter	Test Conditions	Min	Typ	Max	Unit
Static Characteristics						
BV_{CES}	Collector-Emitter Breakdown Voltage	$V_{GE} = 0\text{ V}, I_C = 250\ \mu\text{A}$	650	-	-	V
I_{CES}	Zero Gate Voltage Collector Current	$V_{CE} = 650\text{ V}, V_{GE} = 0$ $T_J=25^\circ\text{C}$ $T_J=150^\circ\text{C}$	- -	- 300	30 -	μA
I_{GES}	Gate Leakage Current	$V_{GE} = \pm 20\text{ V}, V_{CE} = 0\text{ V}$	-	-	± 100	nA
$V_{GE(th)}$	Gate-Emitter Threshold Voltage	$V_{CE} = V_{GE}, I_C = 250\ \mu\text{A}$	4.2	5.0	5.8	V
$V_{CE(SAT)}$	Collector-Emitter Saturation Voltage	$V_{GE} = 15\text{ V}, I_C = 5\text{ A},$ $T_J=25^\circ\text{C}$ $T_J=175^\circ\text{C}$	- -	1.11 1.12	- -	V
		$V_{GE} = 15\text{ V}, I_C = 10\text{ A},$ $T_J=25^\circ\text{C}$ $T_J=150^\circ\text{C}$ $T_J=175^\circ\text{C}$	- -	1.37 1.52 1.55	1.80 - -	
V_{FEC}	Diode Forward Voltage	$V_{GE} = 0\text{ V}, I_F = 5\text{ A},$ $T_J=25^\circ\text{C}$ $T_J=175^\circ\text{C}$	- -	1.35 1.33	- -	V
		$V_{GE} = 0\text{ V}, I_F = 10\text{ A},$ $T_J=25^\circ\text{C}$ $T_J=175^\circ\text{C}$	- -	1.70 1.80	2.20 -	
g_{fs}	Transconductance	$V_{CE} = 10\text{ V}, I_C = 10\text{ A}$	-	4.9	-	S
Dynamic Characteristics						
C_{ies}	Input Capacitance	$V_{CE} = 25\text{ V}, V_{GE} = 0\text{ V},$ $f = 1.0\text{ MHz}$	-	745	-	pF
C_{oes}	Output Capacitance		-	31	-	pF
C_{res}	Reverse Transfer Capacitance		-	7.7	-	pF
Q_g	Total Gate Charge	$V_{CE} = 520\text{ V}, I_C = 10\text{ A},$ $V_{GE} = 15\text{ V}$	-	25	-	nC
t_{SC}	Short Circuit Withstand Time	$V_{CE} = 400\text{ V}, V_{GE} = 15\text{ V}$ $T_J = 100^\circ\text{C}$	5.0	-	-	μs

Electrical Characteristics $T_J=25^\circ\text{C}$ unless otherwise specified

Symbol	Parameter	Test Conditions	Min	Typ	Max	Unit
Switching Characteristics						
$t_{d(on)}$	Turn-On Delay Time	$V_{CE} = 400\text{ V}, I_C = 10\text{ A},$ $R_G = 10\ \Omega, V_{GE} = 0 / 15\text{ V}$ (Note. 2)	-	59	-	ns
t_r	Turn-On Rise Time		-	10.5	-	ns
$t_{d(off)}$	Turn-Off Delay Time		-	100	-	ns
t_f	Turn-Off Fall Time		-	41	-	ns
E_{on}	Turn-On Energy Loss		-	0.018	-	mJ
E_{off}	Turn-Off Energy Loss		-	0.186	-	mJ
E_{tot}	Total Energy Loss		-	0.204	-	mJ
$t_{d(on)}$	Turn-On Delay Time	$V_{CE} = 400\text{ V}, I_C = 10\text{ A},$ $R_G = 10\ \Omega, V_{GE} = 0 / 15\text{ V}$ $T_J = 150\ ^\circ\text{C}$ (Note. 2)	-	58	-	ns
t_r	Turn-On Rise Time		-	11	-	ns
$t_{d(off)}$	Turn-Off Delay Time		-	125	-	ns
t_f	Turn-Off Fall Time		-	62	-	ns
E_{on}	Turn-On Energy Loss		-	0.026	-	mJ
E_{off}	Turn-Off Energy Loss		-	0.262	-	mJ
E_{tot}	Total Energy Loss		-	0.288	-	mJ
$t_{d(on)}$	Turn-On Delay Time	$V_{CE} = 400\text{ V}, I_C = 15\text{ A},$ $R_G = 10\ \Omega, V_{GE} = 0 / 15\text{ V}$ (Note. 2)	-	60	-	ns
t_r	Turn-On Rise Time		-	11.9	-	ns
$t_{d(off)}$	Turn-Off Delay Time		-	90	-	ns
t_f	Turn-Off Fall Time		-	41	-	ns
E_{on}	Turn-On Energy Loss		-	0.025	-	mJ
E_{off}	Turn-Off Energy Loss		-	0.275	-	mJ
E_{tot}	Total Energy Loss		-	0.300	-	mJ

Notes : 2. Include tail current and diode reverse recovery.

Electrical Characteristics $T_J=25^\circ\text{C}$ unless otherwise specified

Symbol	Parameter	Test Conditions	Min	Typ	Max	Unit
Switching Characteristics						
$t_{d(on)}$	Turn-On Delay Time	$V_{CE} = 400\text{ V}$, $I_C = 15\text{ A}$, $R_G = 10\ \Omega$, $V_{GE} = 0 / 15\text{ V}$ $T_J = 150\ ^\circ\text{C}$ (Note. 2)	-	61	-	ns
t_r	Turn-On Rise Time		-	12.5	-	ns
$t_{d(off)}$	Turn-Off Delay Time		-	108	-	ns
t_f	Turn-Off Fall Time		-	55	-	ns
E_{on}	Turn-On Energy Loss		-	0.033	-	mJ
E_{off}	Turn-Off Energy Loss		-	0.380	-	mJ
E_{tot}	Total Energy Loss		-	0.413	-	mJ
Diode Reverse Recovery Characteristics						
t_{rr}	Diode Reverse Recovery Time	$V_R = 400\text{ V}$, $I_F = 10\text{ A}$, $di/dt = 1,000\text{ A}/\mu\text{s}$	-	58.5	-	ns
I_{rr}	Diode Reverse Recovery Current		-	9.7	-	A
Q_{rr}	Diode Reverse Recovery Charge		-	0.289	-	μC
t_{rr}	Diode Reverse Recovery Time	$V_R = 400\text{ V}$, $I_F = 10\text{ A}$, $T_J = 150\ ^\circ\text{C}$ $di/dt = 1,000\text{ A}/\mu\text{s}$	-	70	-	ns
I_{rr}	Diode Reverse Recovery Current		-	12.4	-	A
Q_{rr}	Diode Reverse Recovery Charge		-	0.492	-	μC

Notes : 2. Include tail current and diode reverse recovery.

IGBT Static Characteristics Figure.

Figure.1 Saturation Voltage characteristics ,Junction Temperature(T_J) 25°C

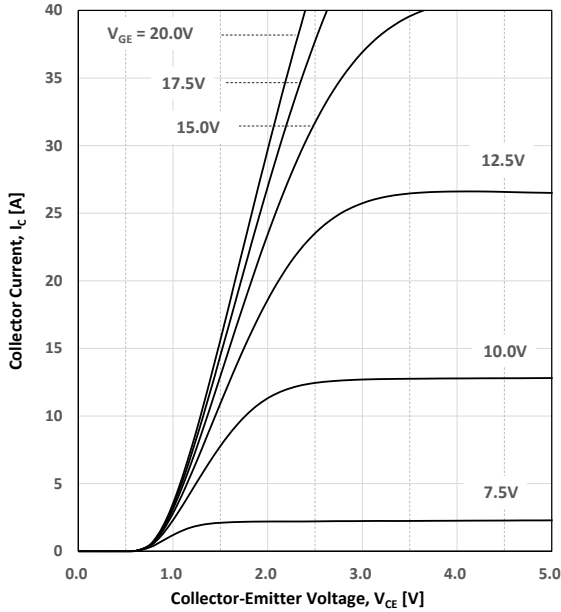

Figure.2 Saturation Voltage characteristics ,Junction Temperature(T_J) 150°C

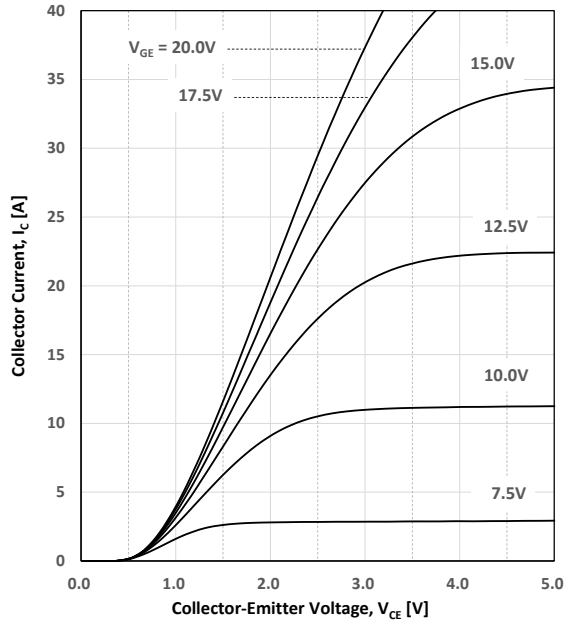

Figure.3 Saturation Voltage characteristics as Junction Temperature, $V_{GE}=15V$

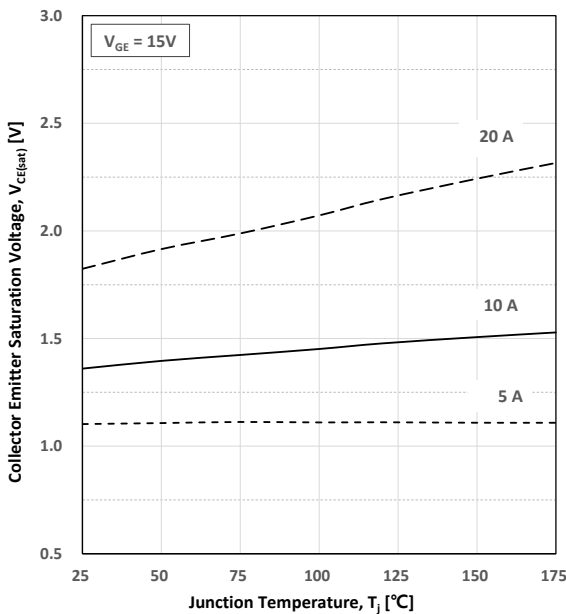

Figure.4 Transconductance characteristics as Junction Temperature, $V_{CE}=10V$

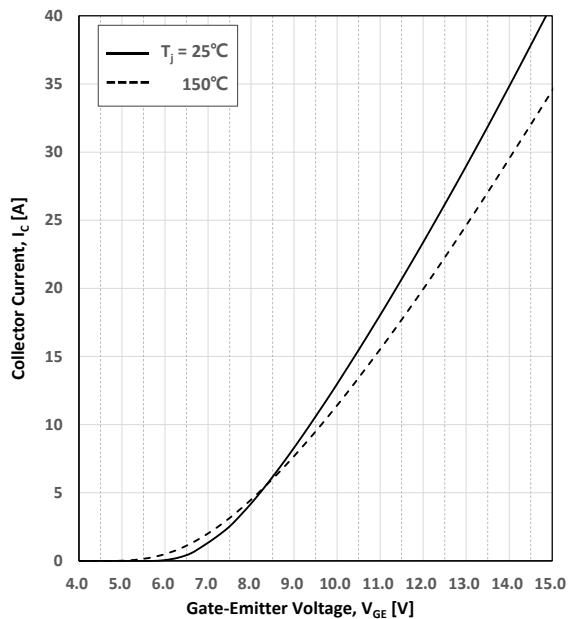

Figure.5 Threshold Voltage characteristics as Junction Temperature

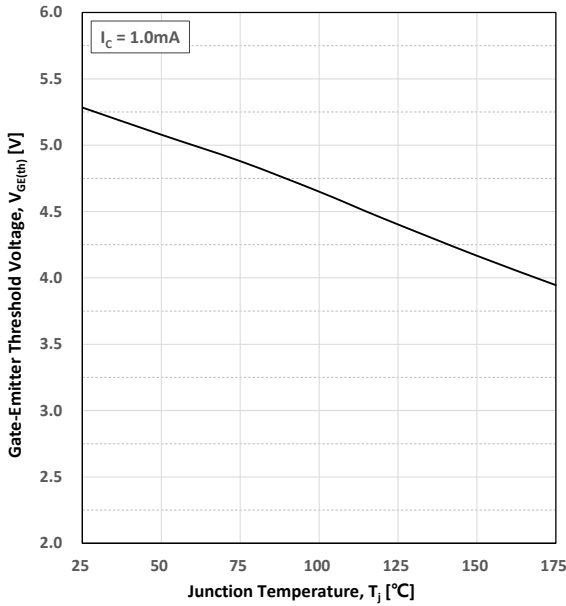
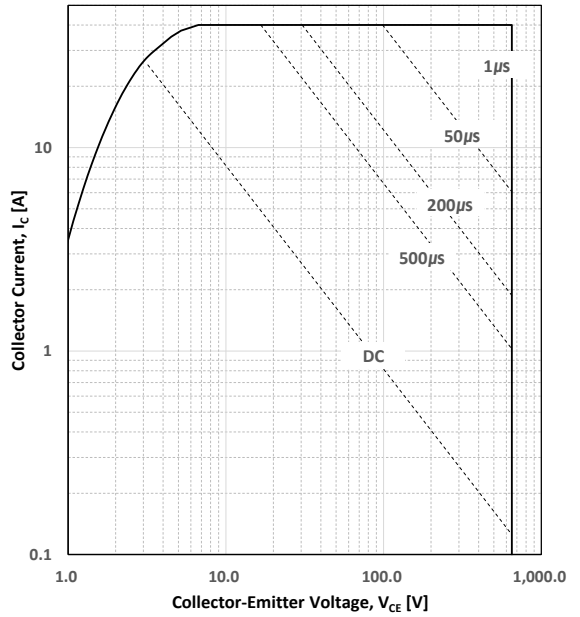

Figure.6 Forward Bias Safe Operating Area ($T_C=25^\circ C$, $T_J \le 175^\circ C$, $V_{GE} \ge 15V$, $t_p=1\mu s$, $D=0$)



IGBT Dynamic Characteristics Figure.

Figure.7 Capacitance characteristics ($f=1MHz$)

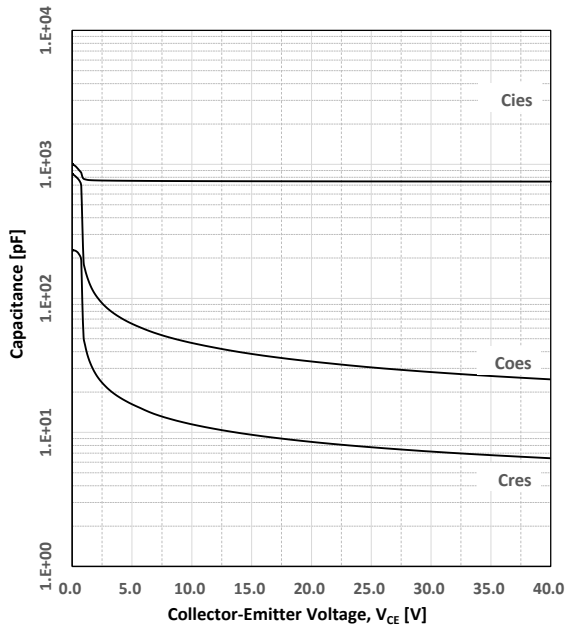
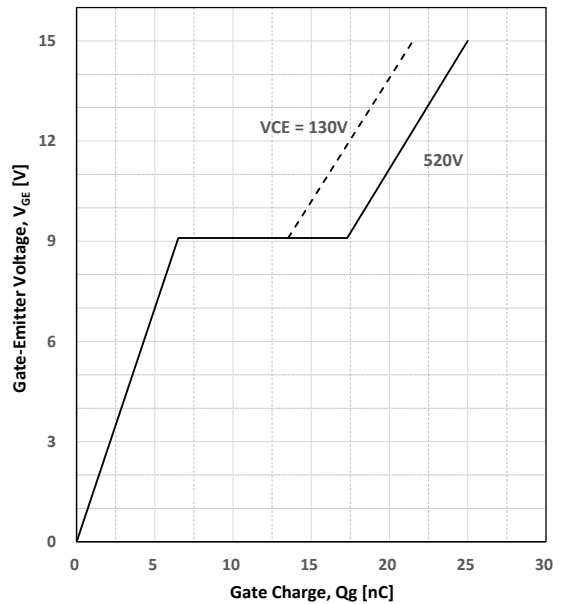

Figure.8 Gate Charge characteristics ($I_C=10A$)



IGBT Switching Characteristics Figure.

Figure.9 Switching Times as Gate Resistance
 ($V_{CE}=400V, I_C=10A, V_{GE}=15V, T_J=25^\circ C$)

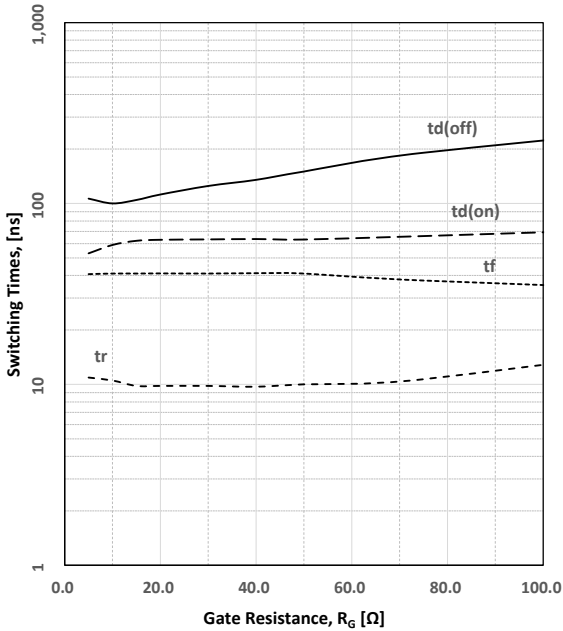

Figure.10 Switching Loss as Gate Resistance
 ($V_{CE}=400V, I_C=10A, V_{GE}=15V, T_J=25^\circ C$)

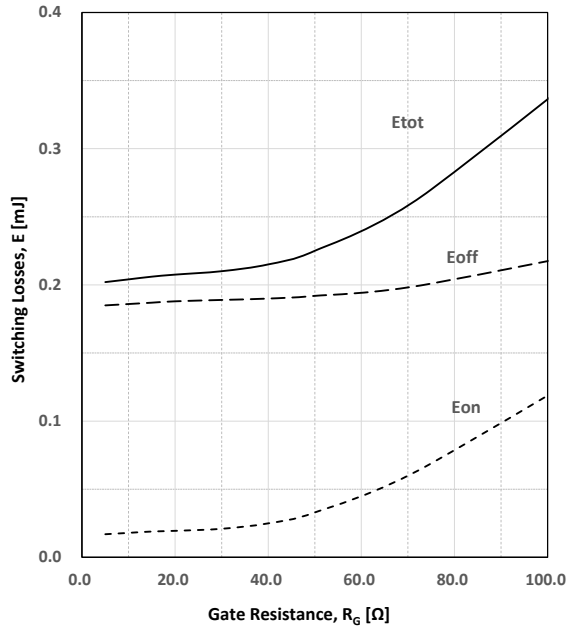

Figure.11 Switching Times as Collector Current
 ($V_{CE}=400V, V_{GE}=15V, R_g=10\Omega, T_J=25^\circ C$)

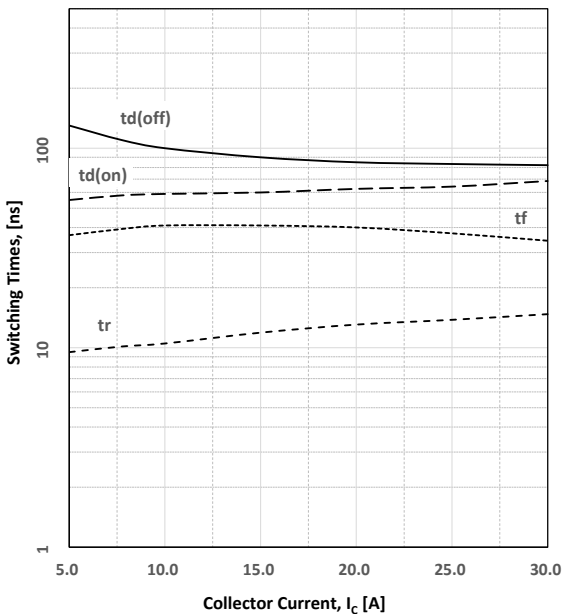

Figure.12 Switching Loss as Collector Current
 ($V_{CE}=400V, V_{GE}=15V, R_g=10\Omega, T_J=25^\circ C$)

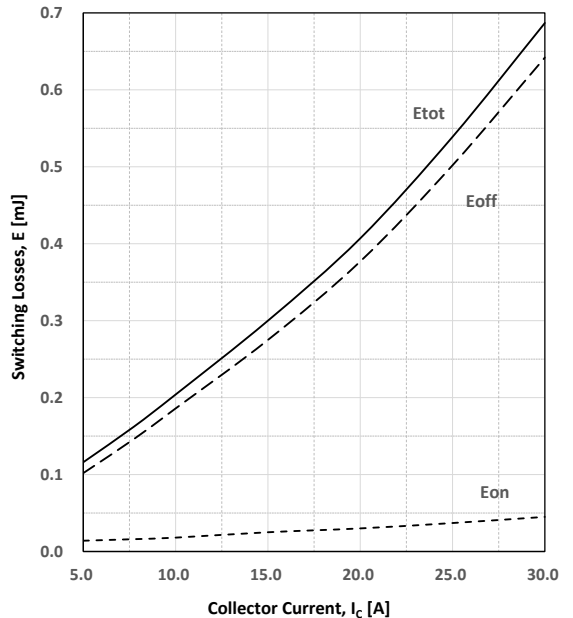

Figure.13 Switching Times as Collector Voltage
 ($I_C=10A$, $V_{GE}=15V$, $R_g=10\Omega$, $T_J=25^\circ C$)

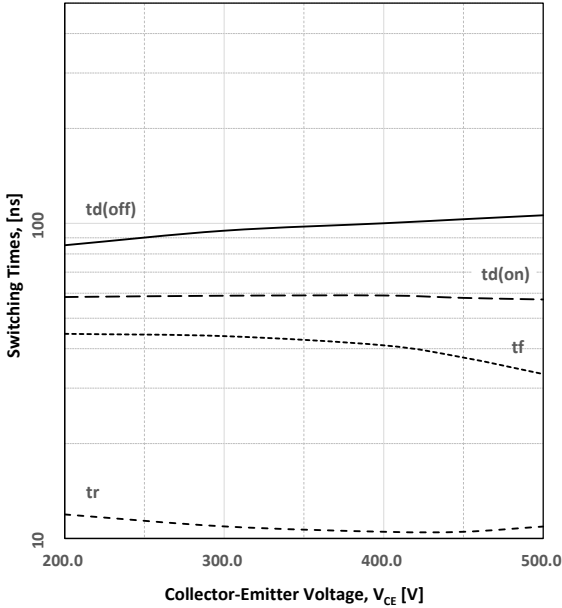

Figure.14 Switching Loss as Collector Voltage
 ($I_C=10A$, $V_{GE}=15V$, $R_g=10\Omega$, $T_J=25^\circ C$)

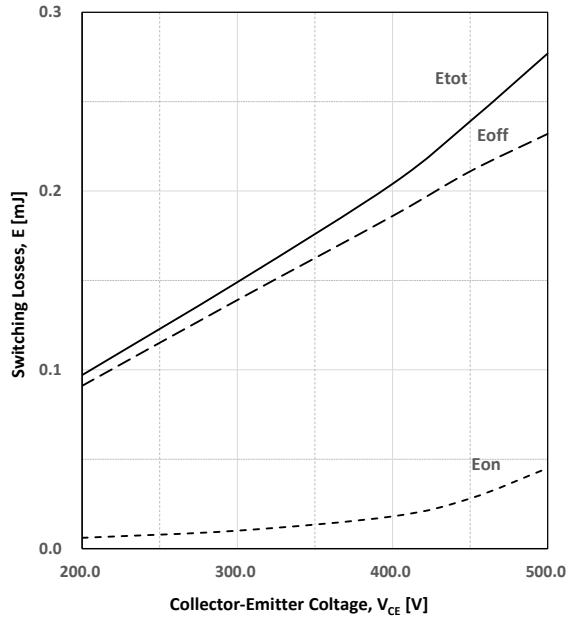

Figure.15 Switching Times as Gate Resistance
 ($V_{CE}=400V$, $I_C=10A$, $V_{GE}=15V$, $T_J=150^\circ C$)

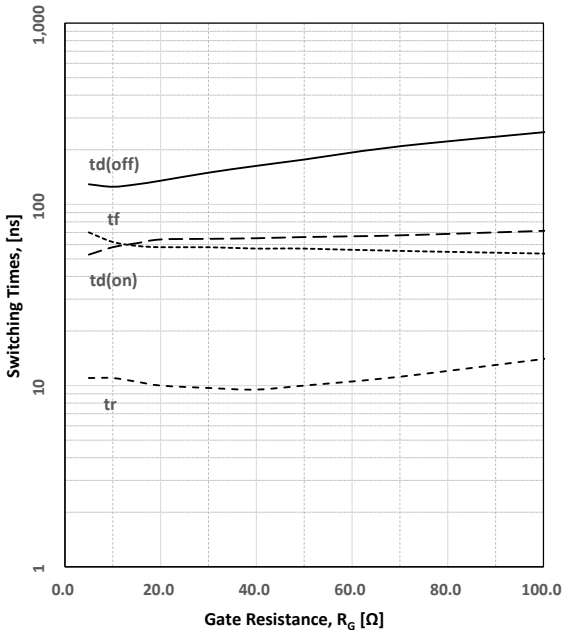

Figure.16 Switching Loss as Gate Resistance
 ($V_{CE}=400V$, $I_C=10A$, $V_{GE}=15V$, $T_J=150^\circ C$)

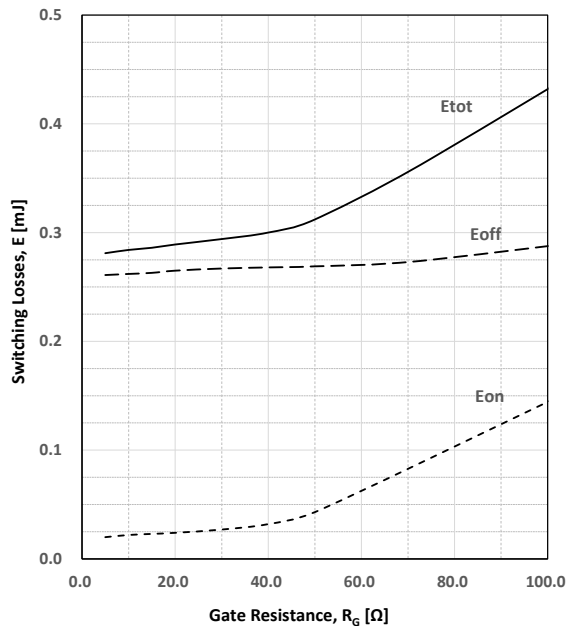

Figure.17 Switching Times as Collector Current
 ($V_{CE}=400V$, $V_{GE}=15V$, $R_g=10\Omega$, $T_J=150^\circ C$)

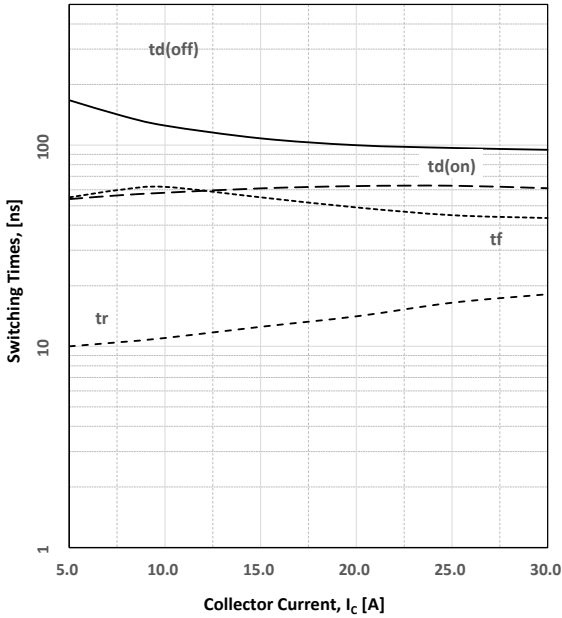

Figure.18 Switching Loss as Collector Current
 ($V_{CE}=400V$, $V_{GE}=15V$, $R_g=10\Omega$, $T_J=150^\circ C$)

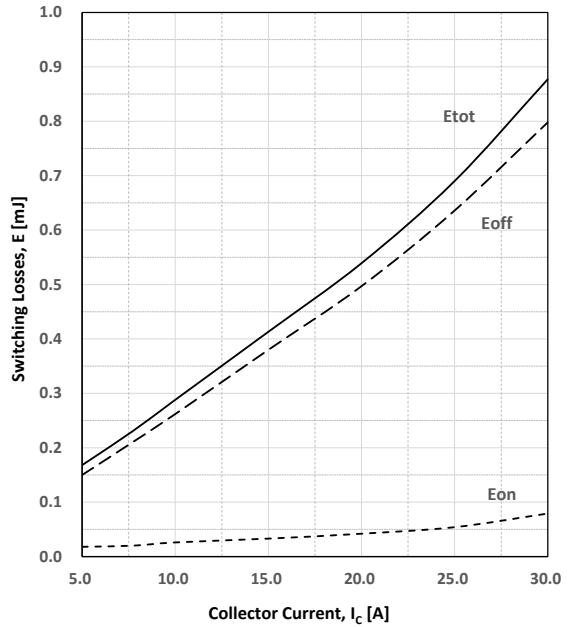

Figure.19 Switching Times as Collector Voltage
 ($I_C=10A$, $V_{GE}=15V$, $R_g=10\Omega$, $T_J=150^\circ C$)

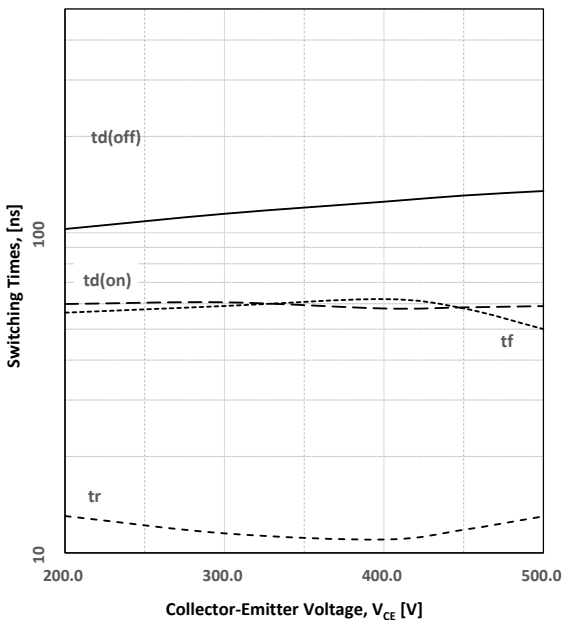

Figure.20 Switching Loss as Collector Voltage
 ($I_C=10A$, $V_{GE}=15V$, $R_g=10\Omega$, $T_J=150^\circ C$)

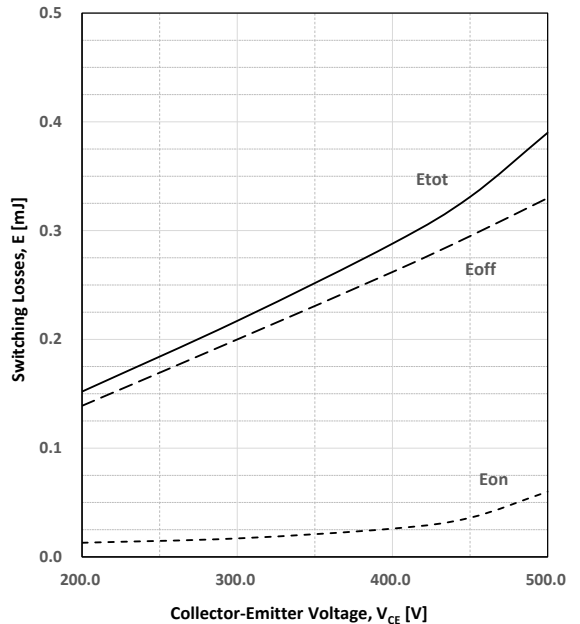

Figure.21 Switching Times as Junction Temp.
 ($V_{CE}=400V, I_C=10A, V_{GE}=15V, R_g=10\Omega$)

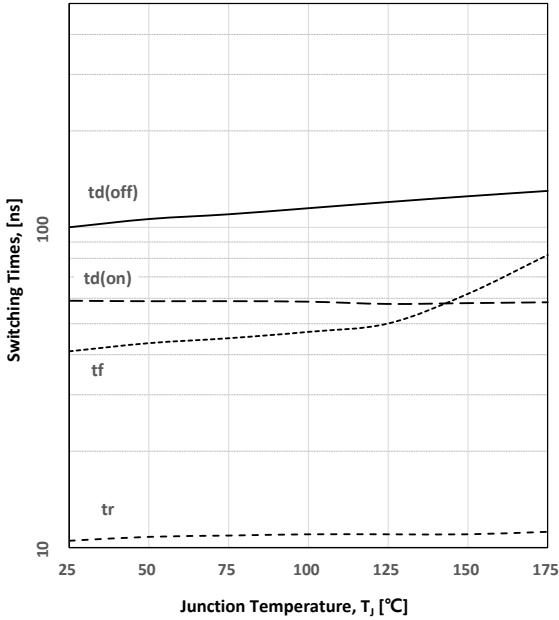
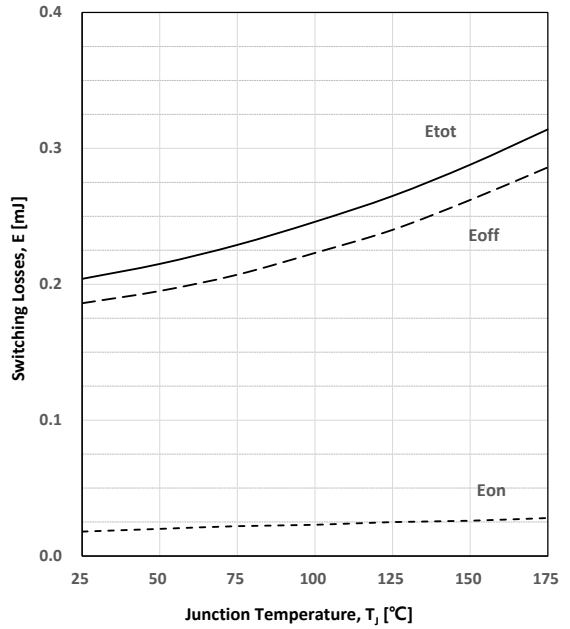
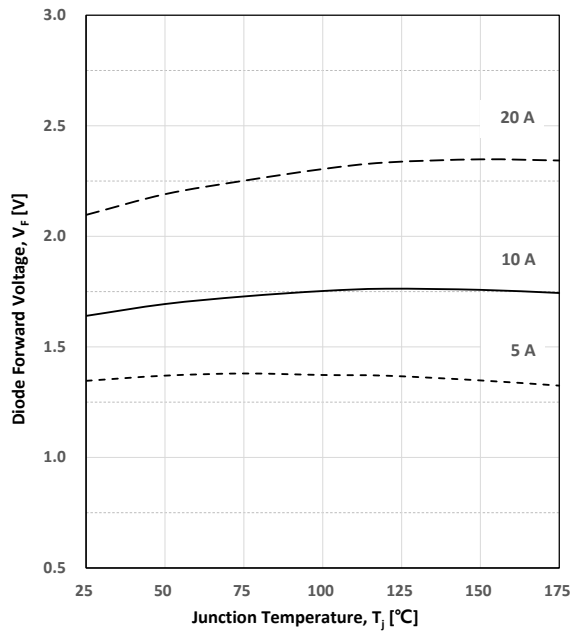
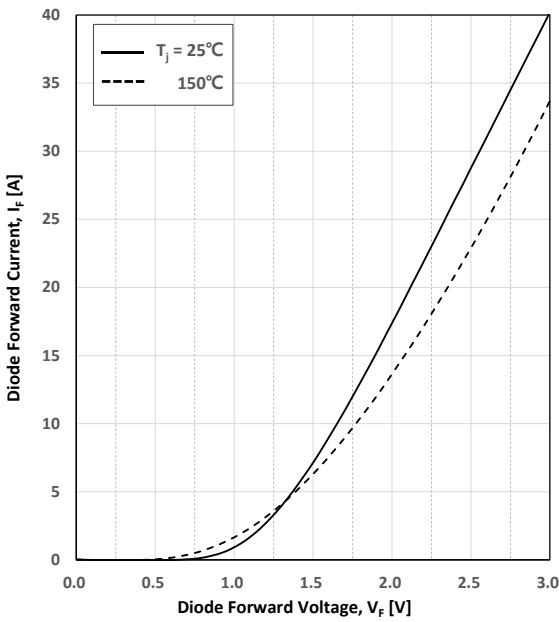

Figure.22 Switching Loss as Junction Temp.
 ($V_{CE}=400V, I_C=10A, V_{GE}=15V, R_g=10\Omega$)



Diode Static Characteristics Figure.

Figure.23 Diode Forward current characteristics as Junction Temperature and Forward current



Diode Reverse Recovery Characteristics Figure.

Figure.24 Reverse Recovery Current as di/dt ($V_R=400V$, $I_F=10A$)

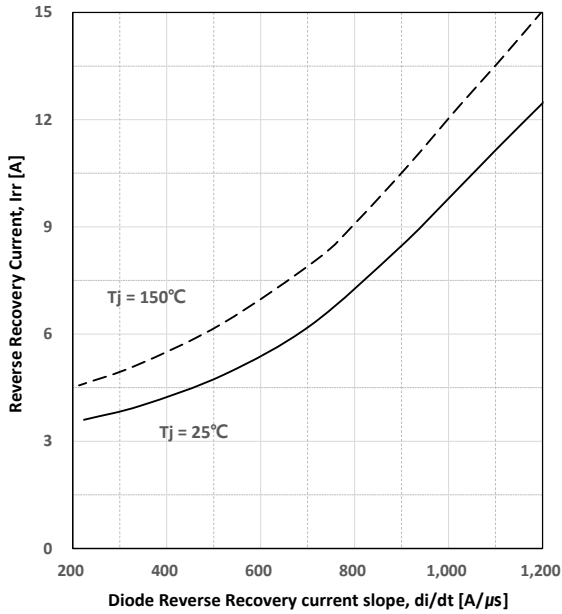

Figure.25 Reverse Recovery Time as di/dt ($V_R=400V$, $I_F=10A$)

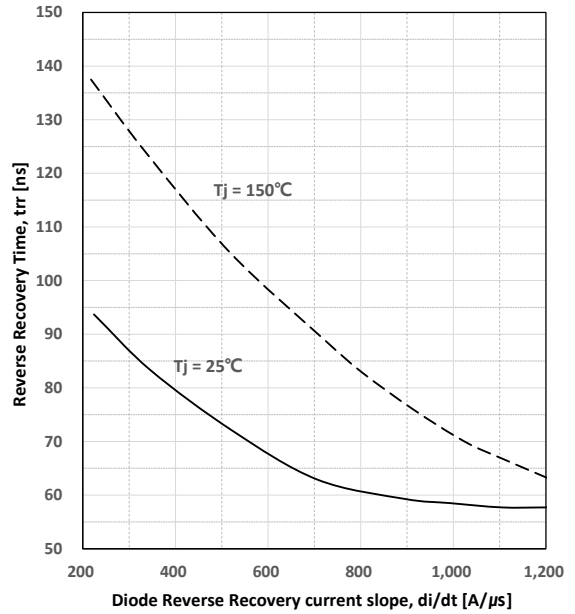
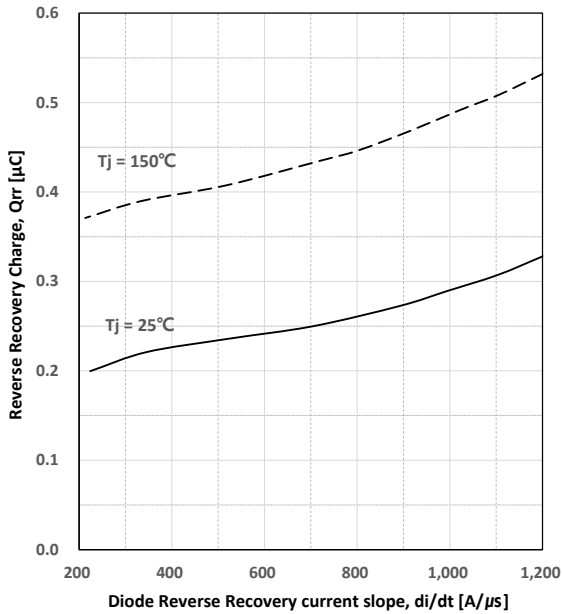
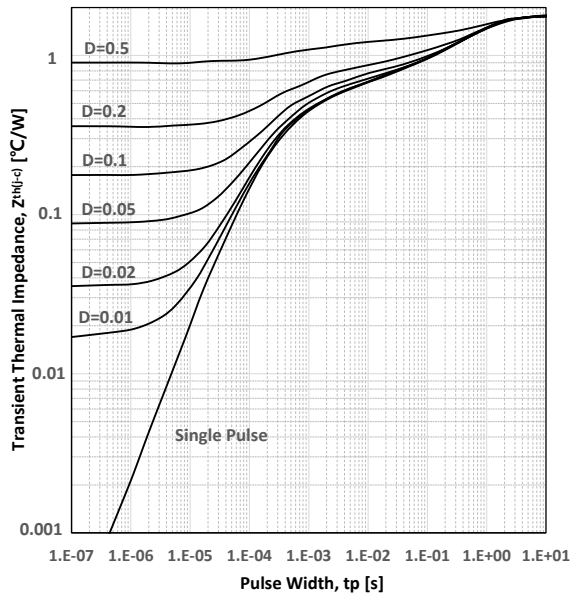

Figure.26 Reverse Recovery Charge as di/dt ($V_R=400V$, $I_F=10A$)



Transient Thermal Impedance Figure.

Figure.27 IGBT Transient Thermal Impedance



Ref. 1) Switching Test Circuit

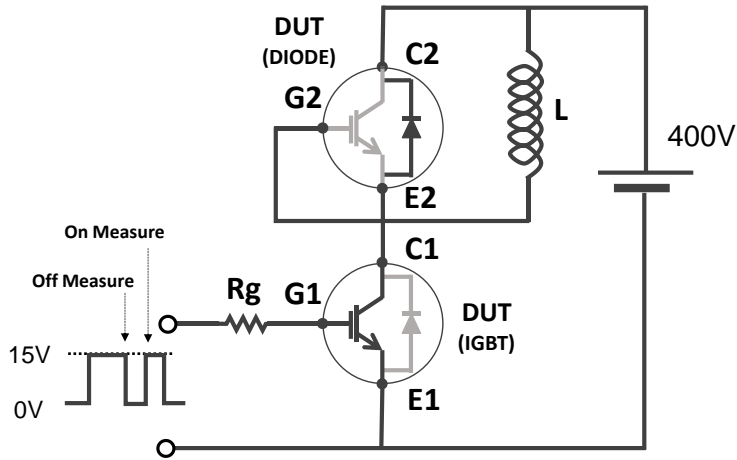

Ref. 2) Definition of switching time and loss

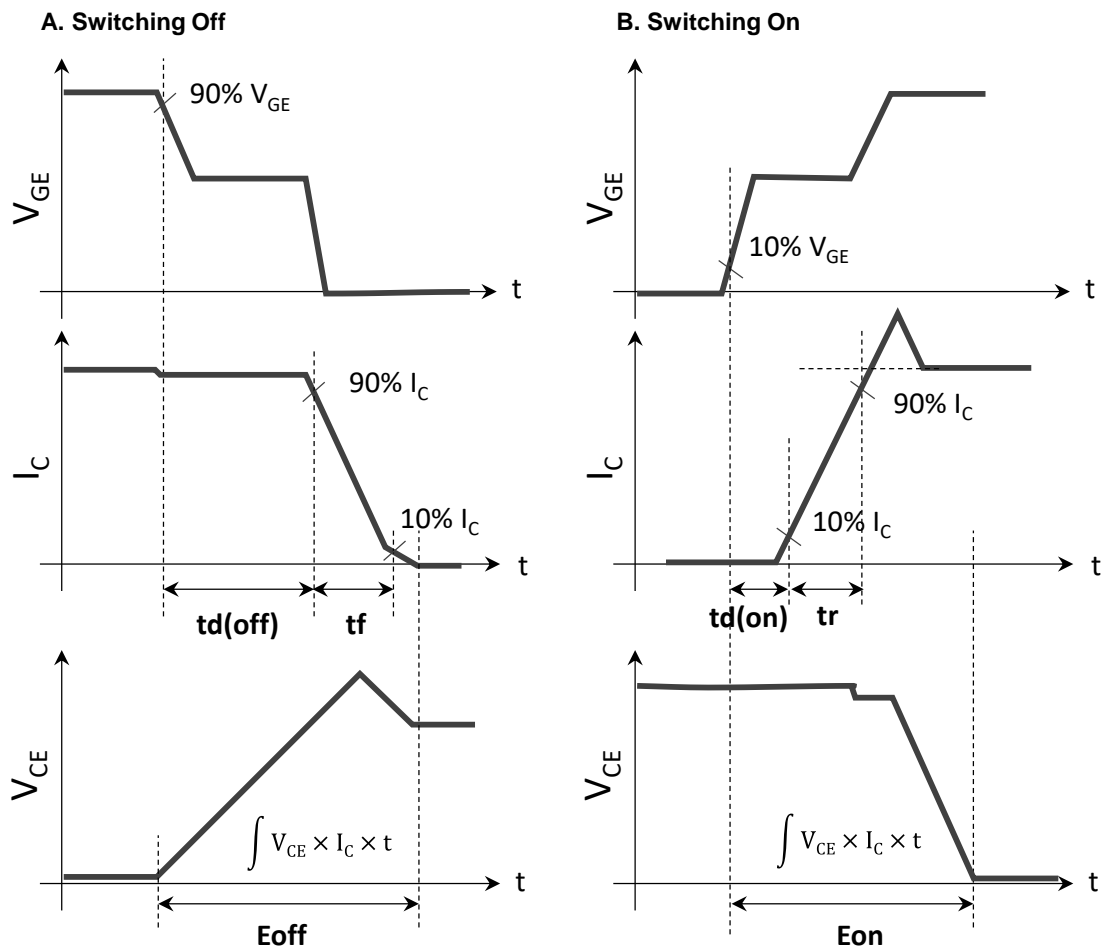

Ref. 3) Definition of Diode switching time

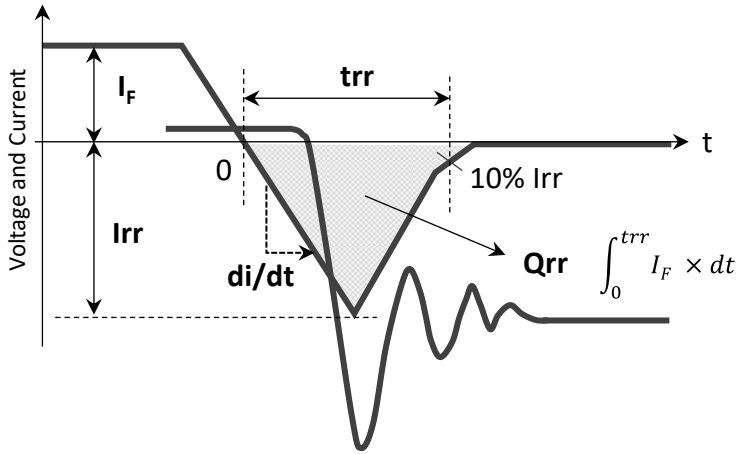

Package Dimension : TO-220

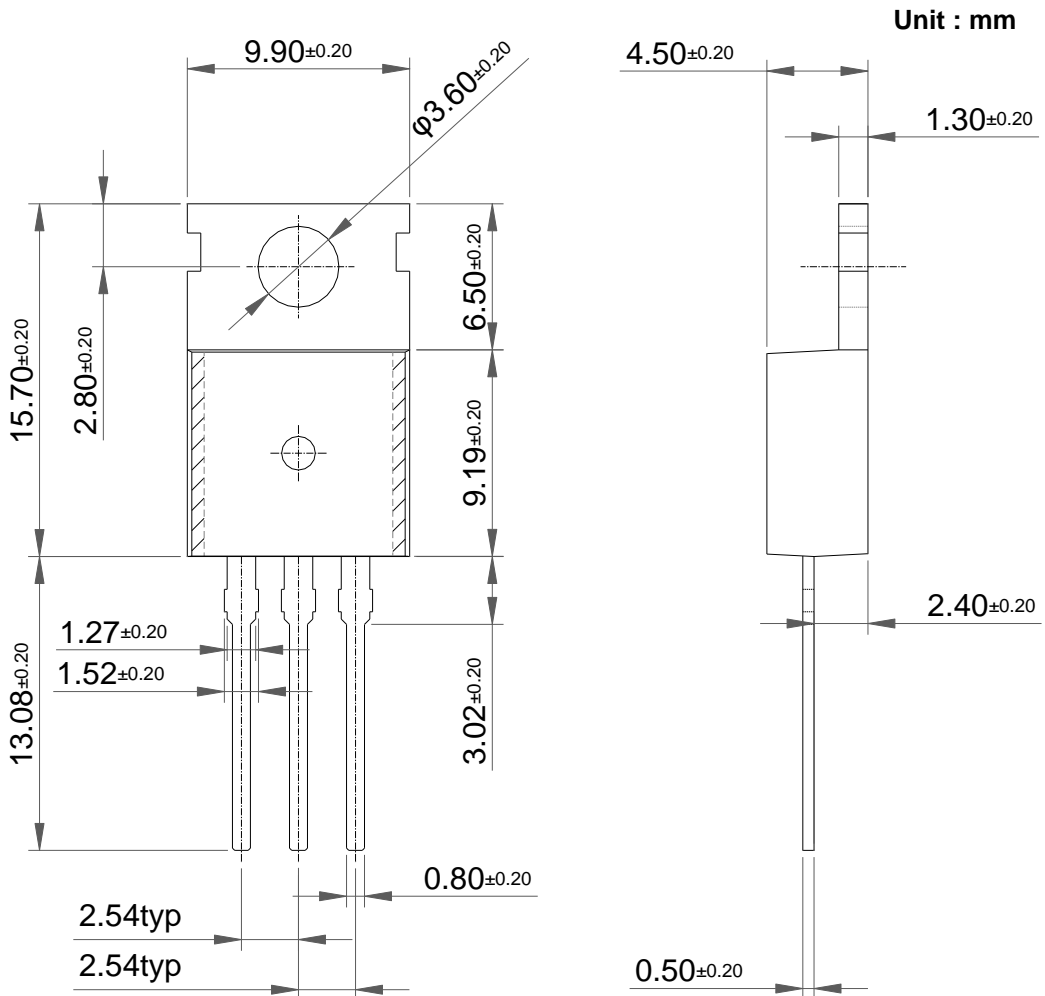

Revision History

VERSION	DESCRIPTION	DATE	APPROVED
0	Original Specification sheet	24.01.19	Tomas Song
1			
2			
3			
4			
5			
6			
7			
8			
9			
10			